

Material: Messing vernickelt (Verstärkungshülsen und Schneidringe Messing blank)
 Druckbereich: max. 60 bar
 Temperatur: max. 150 °C
 Einsatzbereich: Sie werden für pneumatische, ölhydraulische oder hydraulische Kreisläufe verwendet. Im Allgemeinen können sie mit allen Medien eingesetzt werden, die mit Messing, bzw. vernickeltem Messing, verträglich sind.

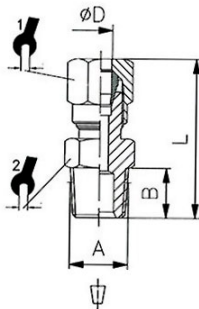

N 29

Gerade Einschraubverschraubung, Außengewinde konisch, Gewinde nach ISO 7-1

Artikel Nr.	Typen Nr.	ØD mm	Gewinde A	B mm	L mm	SW 1 mm	SW 2 mm
111964	N 21	4	R 1/8	8,0	27,0	10	10
111965	N 23	6	R 1/8	8,0	28,0	12	12
111966	N 24	8	R 1/8	8,0	29,5	14	12
111967	N 28	6	R 1/4	11,0	32,5	12	14
111968	N 29	8	R 1/4	11,0	33,0	14	14
111969	N 30	10	R 1/4	11,0	37,5	19	17
111970	N 34	8	R 3/8	11,5	33,0	14	17
111971	N 35	10	R 3/8	11,5	38,0	19	17
111972	N 36	12	R 3/8	11,5	39,0	22	19
111973	N 39	10	R 1/2	14,0	40,5	19	22
111974	N 40	12	R 1/2	14,0	41,0	22	22
111975	N 41	15	R 1/2	14,0	42,5	27	22
111976	N 42	18	R 1/2	14,0	43,0	32	26

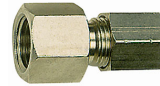
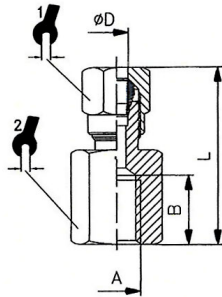

N 64

Manometerverschraubung, mit Innengewinde

Artikel Nr.	Typen Nr.	ØD mm	Gewinde A	B mm	L mm	SW 1 mm	SW 2 mm
111977	N 60	4	G 1/8	8,0	24,5	10	14
111978	N 61	6	G 1/8	8,5	25,5	12	14
111979	N 62	8	G 1/8	8,0	26,5	14	14
111980	N 63	6	G 1/4	11,0	30,0	12	17
111981	N 64	8	G 1/4	11,0	31,0	14	17
111982	N 65	10	G 1/4	11,0	35,5	19	17
111983	N 66	8	G 3/8	11,5	31,0	14	20
111984	N 67	10	G 3/8	11,5	36,5	19	20
111985	N 68	12	G 3/8	11,5	36,0	22	20
111986	N 69	12	G 1/2	15,0	39,5	22	24
111987	N 70	15	G 1/2	15,0	40,0	27	24
111988	N 71	18	G 1/2	15,0	42,0	32	26

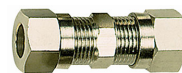
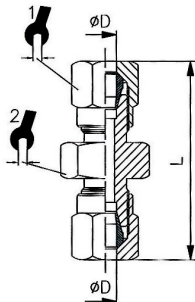

N 55

Gerade Verschraubung, beiderseits Rohranschluss

Artikel Nr.	Typen Nr.	ØD mm	L mm	SW 1 mm	SW 2 mm
111989	N 50	4	34,0	10	10
111990	N 54	6	35,0	12	12
111991	N 55	8	38,5	14	14
111992	N 56	10	47,5	19	17
111993	N 57	12	48,0	22	19
111994	N 58	15	50,0	27	24
111995	N 59	18	56,0	32	26

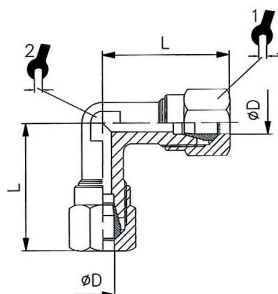

N 75

Winkel-Verschraubung, beiderseits Rohranschluss

Artikel Nr.	Typen Nr.	ØD mm	L mm	SW 1 mm	SW 2 mm
111996	N 73	4	21,0	10	9
111997	N 74	6	23,0	12	9
111998	N 75	8	24,0	14	11
111999	N 76	10	32,0	19	13
112000	N 77	12	34,5	22	15
112001	N 78	15	38,0	27	17
112002	N 79	18	44,0	32	22

Schwenkbare Winkel-Verschraubung, Außengewinde zylindrisch mit O-Ring



N 84

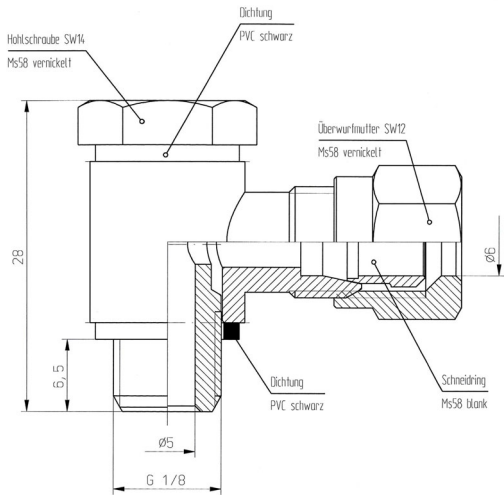

Artikel Nr. N 81
Typen Nr. 112003

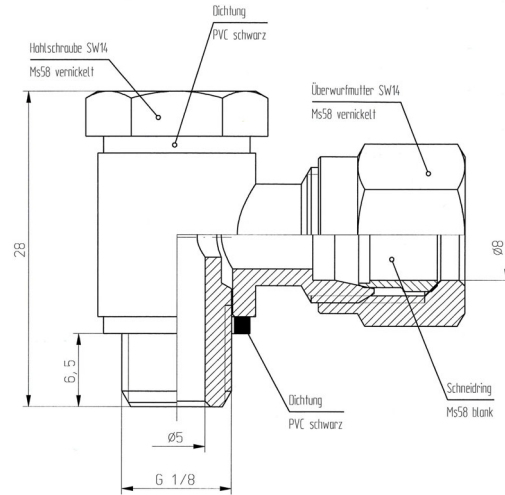

Artikel Nr. N 82
Typen Nr. 112004

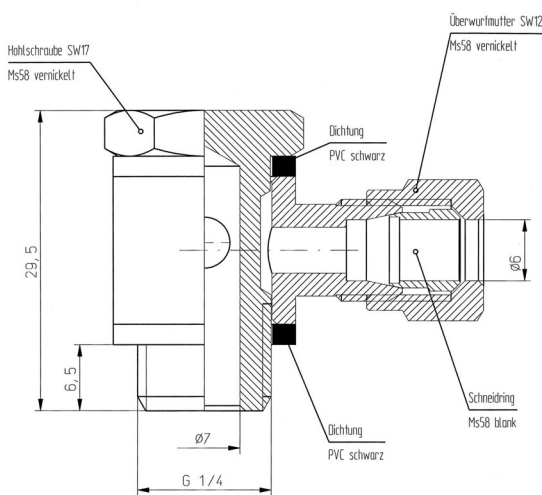

Artikel Nr. N 83
Typen Nr. 112005

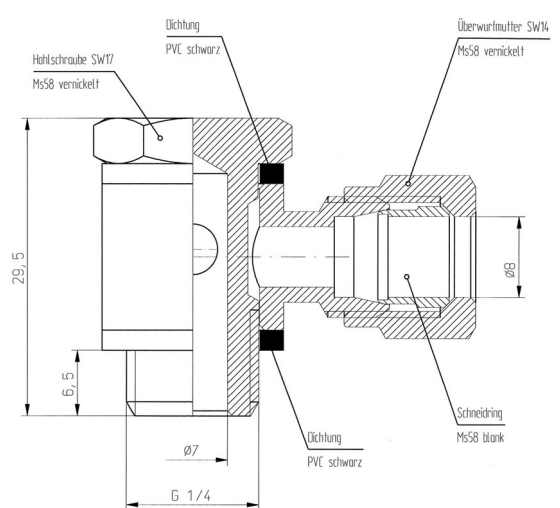

Artikel Nr. N 84
Typen Nr. 112006

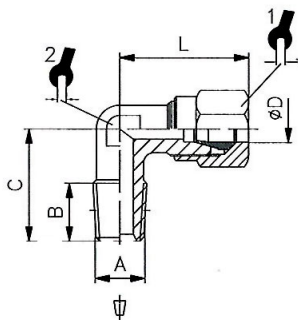

N 93

Winkel-Einschraubverschraubung, Außengewinde konisch nach ISO 7-1

Artikel Nr.	Typen Nr.	ØD mm	Gewinde A	B mm	C mm	L mm	SW 1 mm	SW 2 mm
112007	N 89	4	R 1/8	8,0	16,0	21,0	10	9
112008	N 90	6	R 1/8	8,0	16,0	22,0	12	9
112009	N 91	8	R 1/8	8,0	17,0	24,0	14	11
112010	N 92	6	R 1/4	11,0	20,0	24,5	12	11
112011	N 93	8	R 1/4	11,0	20,0	24,0	14	11
112012	N 94	10	R 1/4	11,0	23,5	32,0	19	13
112013	N 97	8	R 3/8	11,5	24,0	27,0	14	13
112014	N 98	10	R 3/8	11,5	24,0	32,0	19	13
112015	N 99	12	R 3/8	11,5	25,5	34,5	22	15
112016	N 101	10	R 1/2	13,0	28,5	34,0	19	15
112017	N 102	12	R 1/2	13,0	28,5	34,5	22	15
112018	N 103	15	R 1/2	14,0	30,0	38,0	27	17
112019	N 104	18	R 1/2	14,0	34,0	44,0	32	22

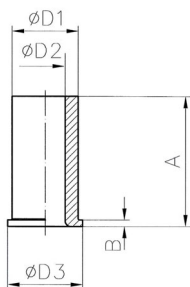

VH 8

Verstärkungshülsen (Messing blank)

Artikel Nr.	Typen Nr.	Rohr-Außen-Ø mm	D1 mm	D2 mm	D3 mm	A mm	B mm
112020	VH 2	4x2	2,0	1,3	3,5	8,0	0,3
112021	VH 4	6x4	4,0	3,5	5,0	10,0	0,4
112022	VH 6	8x6	6,0	5,5	8,0	15,0	0,5
112023	VH 8	10x8	8,0	7,0	10,0	15,0	0,5
112024	VH 9	12x9	9,0	8,0	12,0	15,0	0,5
112025	VH 10	12x10	10,0	9,0	12,0	15,0	0,5
112026	VH 12	15x12	12,0	11,0	15,0	15,0	0,5
112027	VH 14	18x14	14,0	13,0	17,0	18,0	0,6

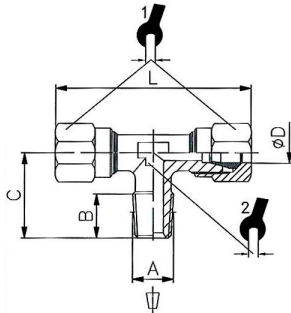

N 117

T-Einschraubverschraubung, Außengewinde konisch nach ISO 7-1

Artikel Nr.	Typen Nr.	ØD mm	Gewinde A	B mm	C mm	L mm	SW 1 mm	SW 2 mm
112028	N 110	4	R 1/8	8,0	16,0	44,0	10	9
112029	N 112	6	R 1/8	8,0	16,0	46,0	12	9
112030	N 115	8	R 1/8	8,0	17,0	48,0	14	11
112031	N 116	6	R 1/4	11,0	20,0	46,0	12	11
112032	N 117	8	R 1/4	11,0	20,0	48,0	14	11
112033	N 118	10	R 1/4	11,0	23,5	64,0	19	13
112034	N 119	8	R 3/8	11,5	24,0	54,0	14	13
112035	N 120	10	R 3/8	11,5	24,0	64,0	19	13
112036	N 121	12	R 3/8	11,5	25,5	69,0	22	15
112037	N 124	12	R 1/2	14,0	28,5	69,0	22	14
112038	N 125	15	R 1/2	14,0	30,0	76,0	27	17
112039	N 126	18	R 1/2	14,0	34,0	88,0	32	22

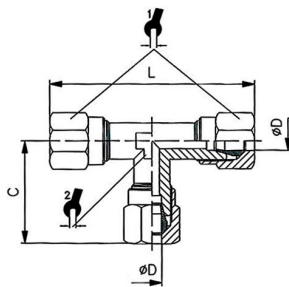

N 136

T-Verschraubung, allseitig Rohranschluss

Artikel Nr.	Typen Nr.	ØD mm	C mm	L mm	SW 1 mm	SW 2 mm
112040	N 130	4	21,0	44,0	10	9
112041	N 135	6	23,0	46,0	12	9
112042	N 136	8	24,0	48,0	14	11
112043	N 137	10	32,0	64,0	19	13
112044	N 138	12	34,5	69,0	22	15
112045	N 139	15	38,0	76,0	27	17
112046	N 140	18	44,0	88,0	32	22

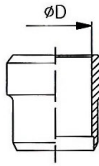

N 353

Schneidringe (Messing blank)

Artikel Nr.	Typen Nr.	ØD mm
112047	N 350	4
112048	N 352	6
112049	N 353	8
112050	N 362	10
112051	N 363	12
112052	N 364	15
112053	N 365	18

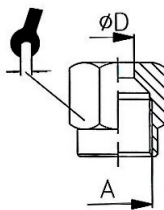

N 403

Überwurfmuttern

Artikel Nr.	Typen Nr.	ØD mm	A mm	SW mm
112054	N 400	4	M8x1,0	10
112055	N 402	6	M10x1,0	12
112056	N 403	8	M12x1,0	14
112057	N 407	10	M16x1,5	19
112058	N 408	12	M18x1,5	22
112059	N 409	15	M22x1,5	27
112060	N 410	18	M26x1,5	32